

WINGED GEMINI

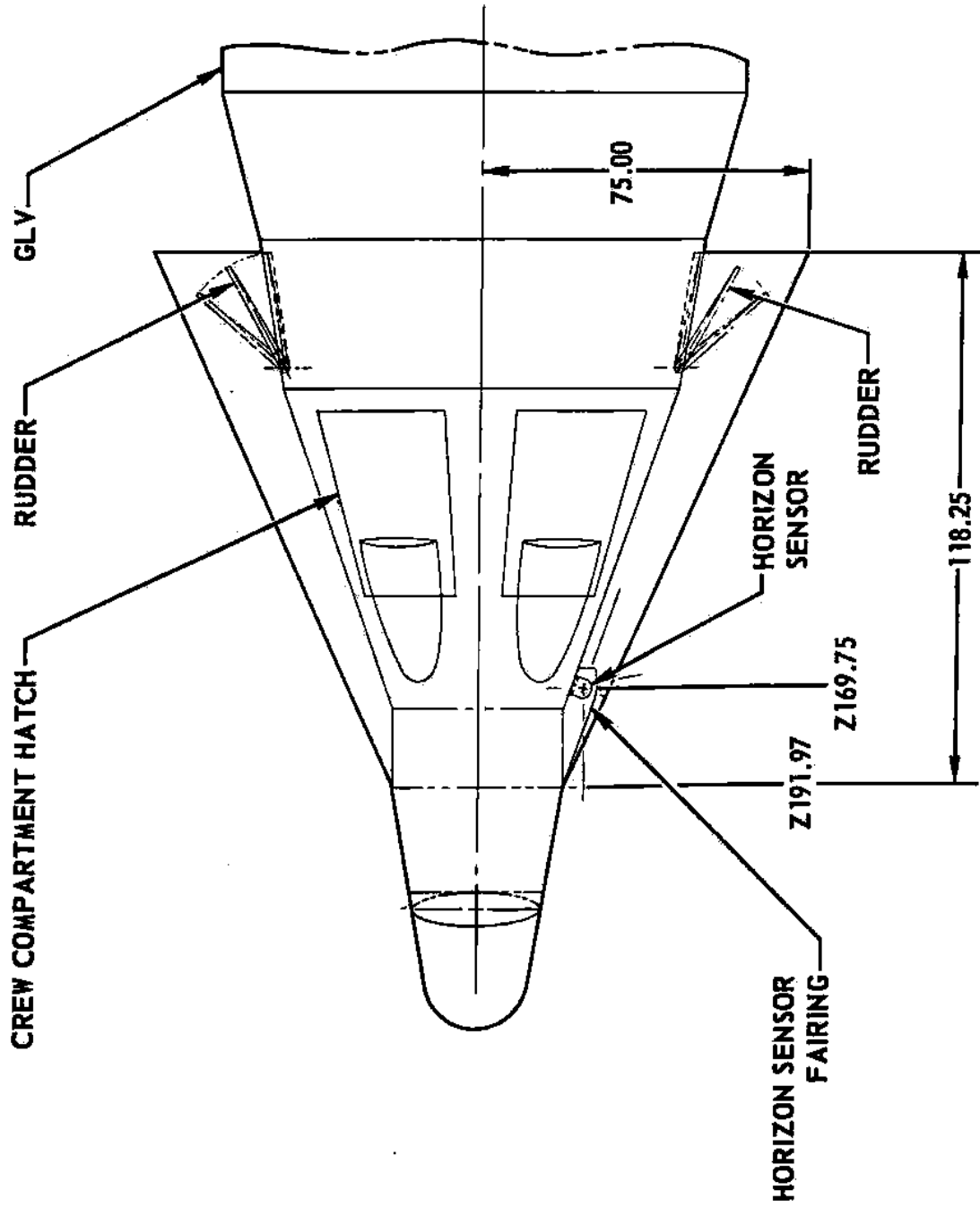

MCDONNELL

WINGED GEMINI

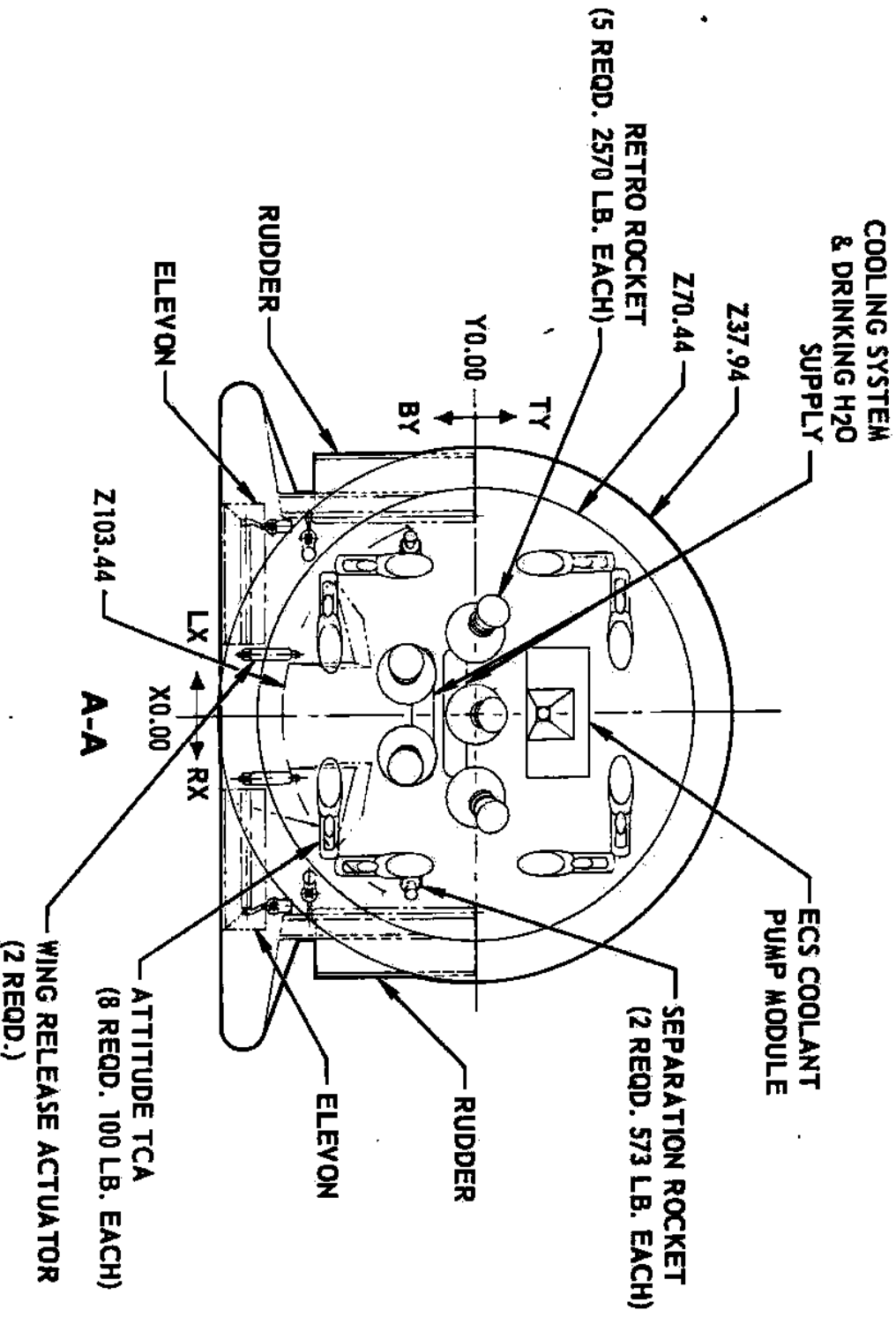

THIS VIEW LOOKING FORWARD

ADVANCED GEMINI SPACECRAFT TO EXTEND USEFULNESS OF PROGRAM

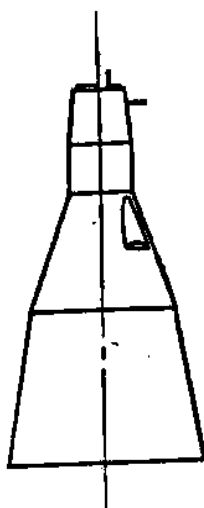

GEMINI

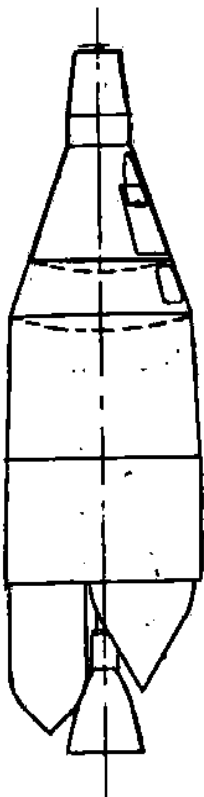

RESCUE GEMINI

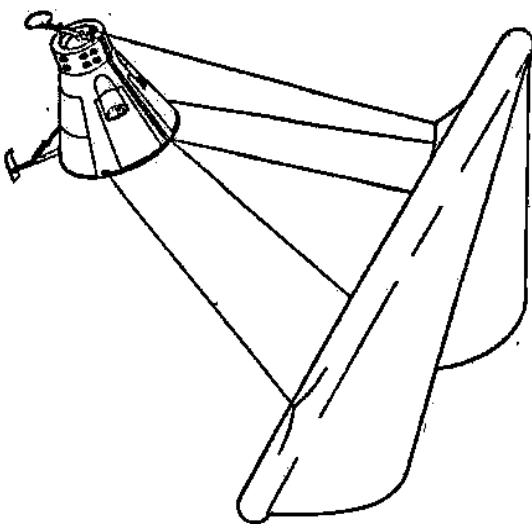

PARAGLIDER GEMINI

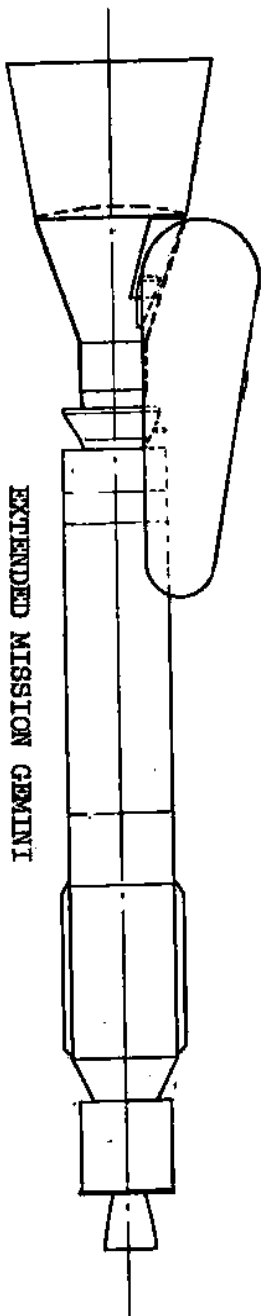

EXTENDED MISSION GEMINI

ADVANCED GEMINI SPACECRAFT TO EXTEND USEFULNESS OF PROGRAM

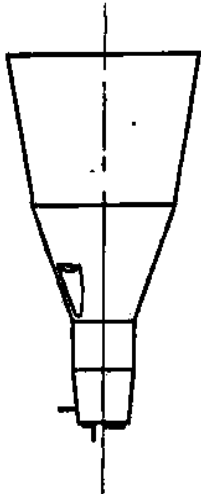

GEMINI

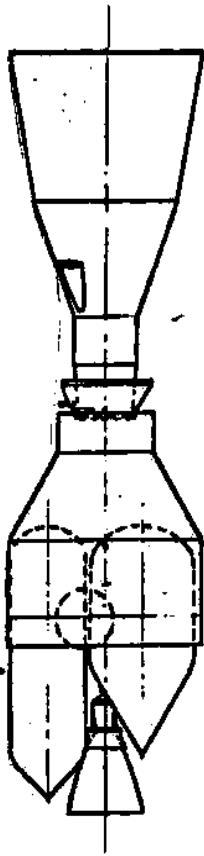

LUNAR ORBIT GEMINI

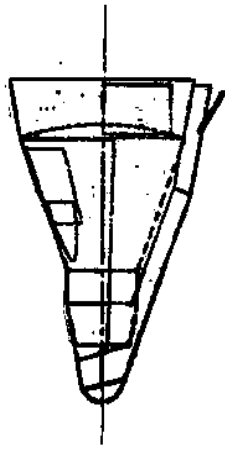

WINGED GEMINI

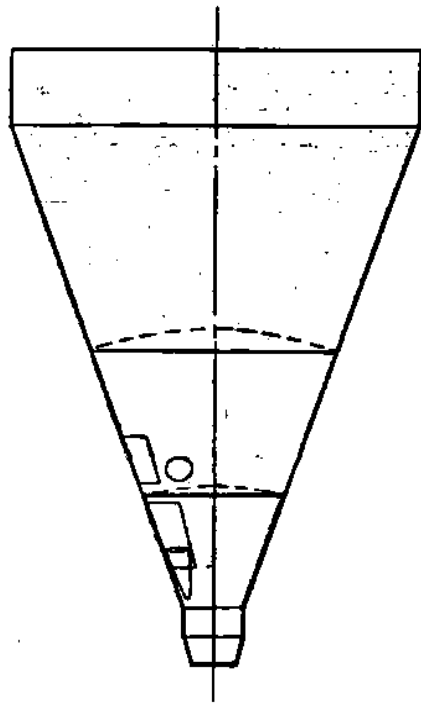

GEMINI TRANSPORT

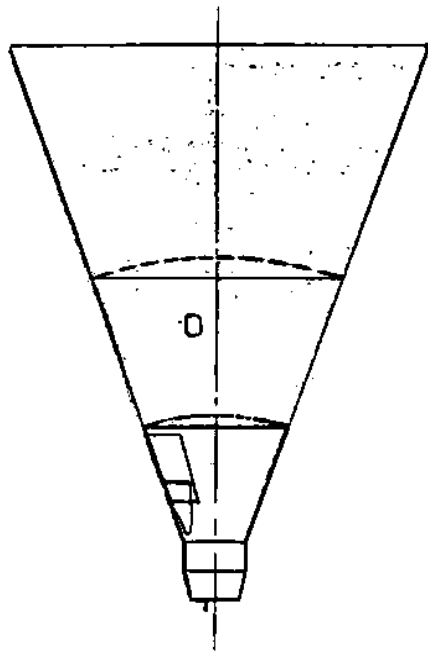

GEMINI OBSERVATORY

ALTERNATE 3 MAN LUNAR ORBIT/ LUNAR SURFACE RESCUE VEHICLE

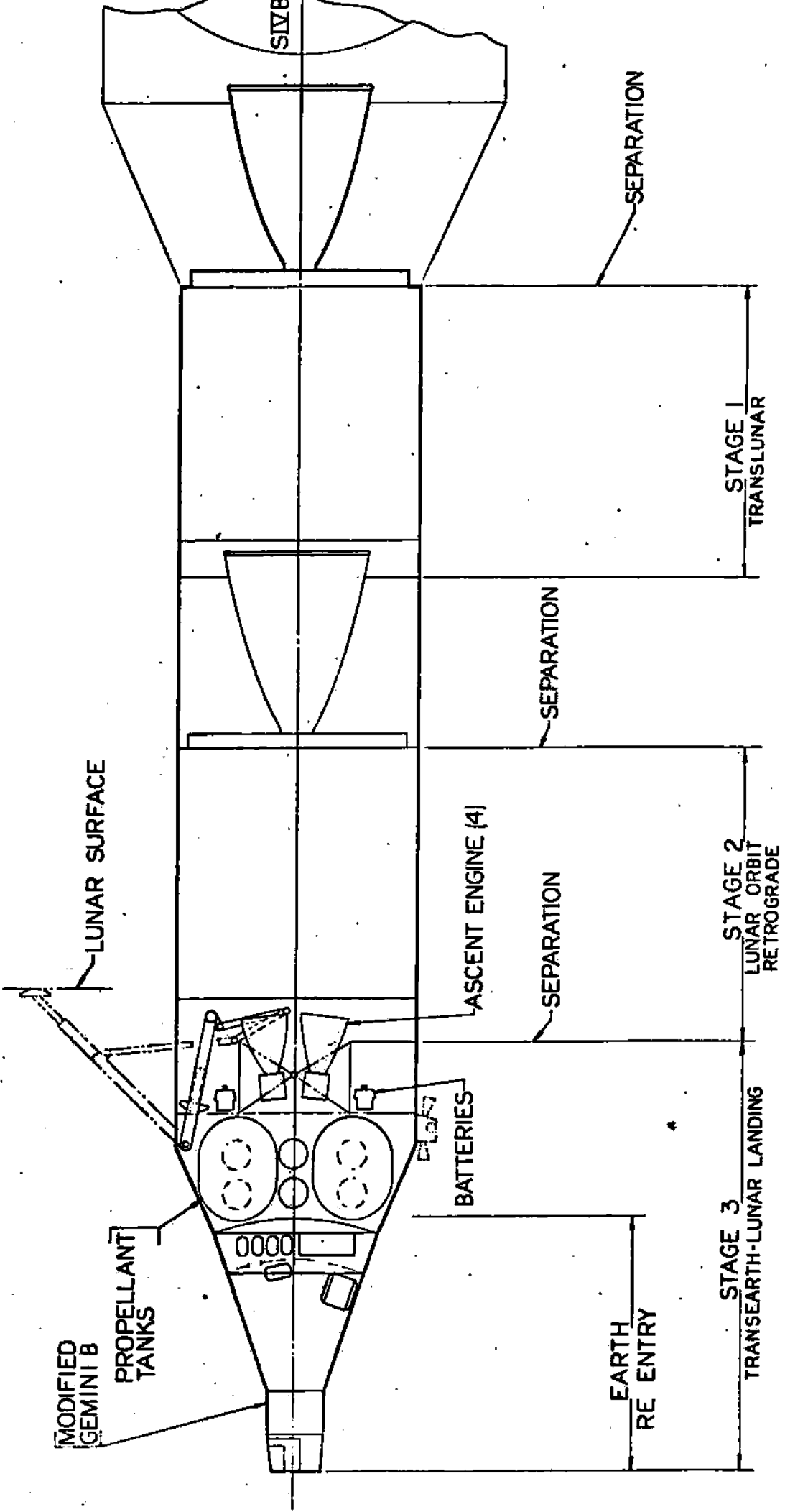

LUNAR SURFACE RESCUE SPACECRAFT

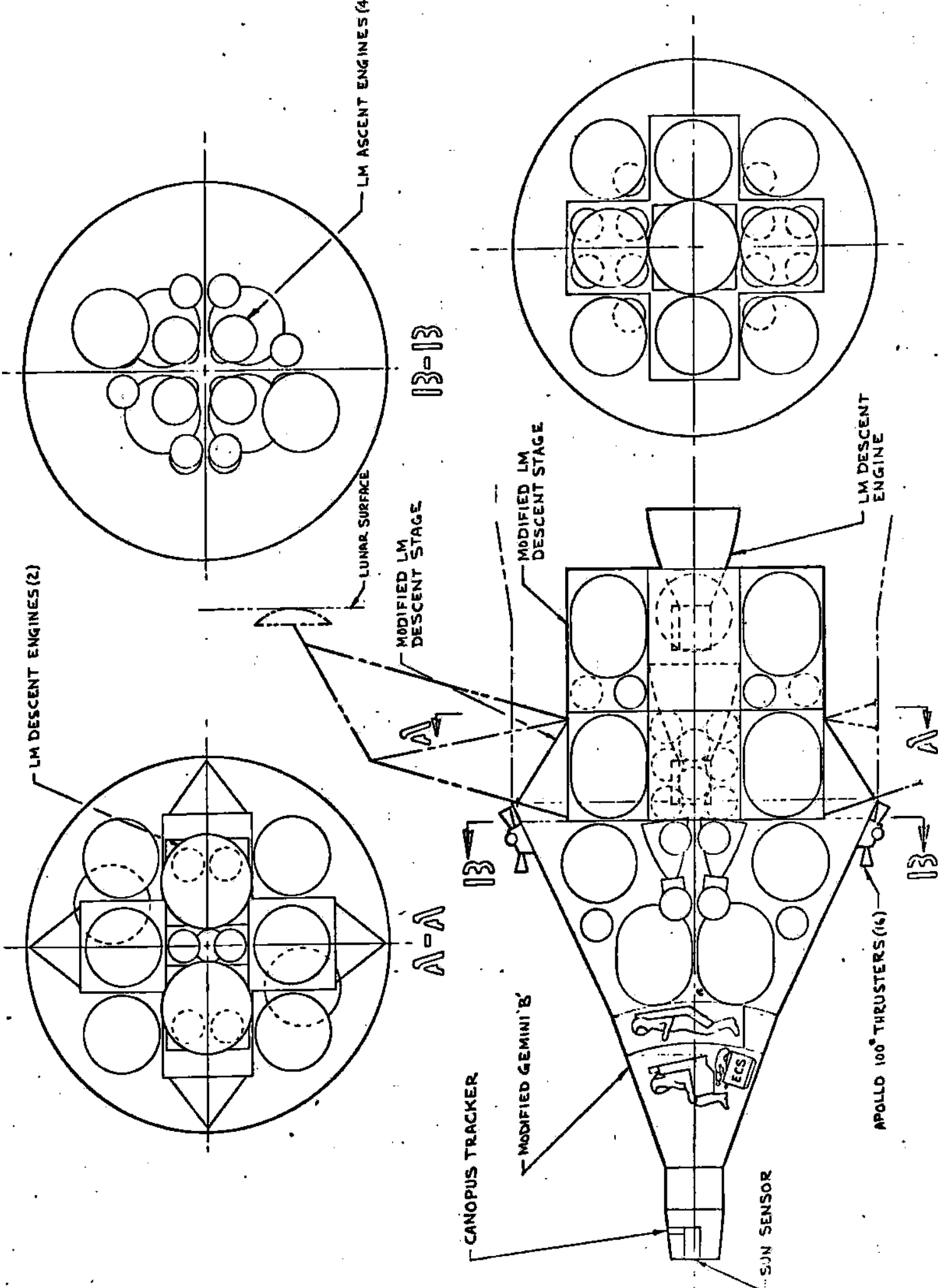

LUNAR SURFACE SURVIVAL SHELTER

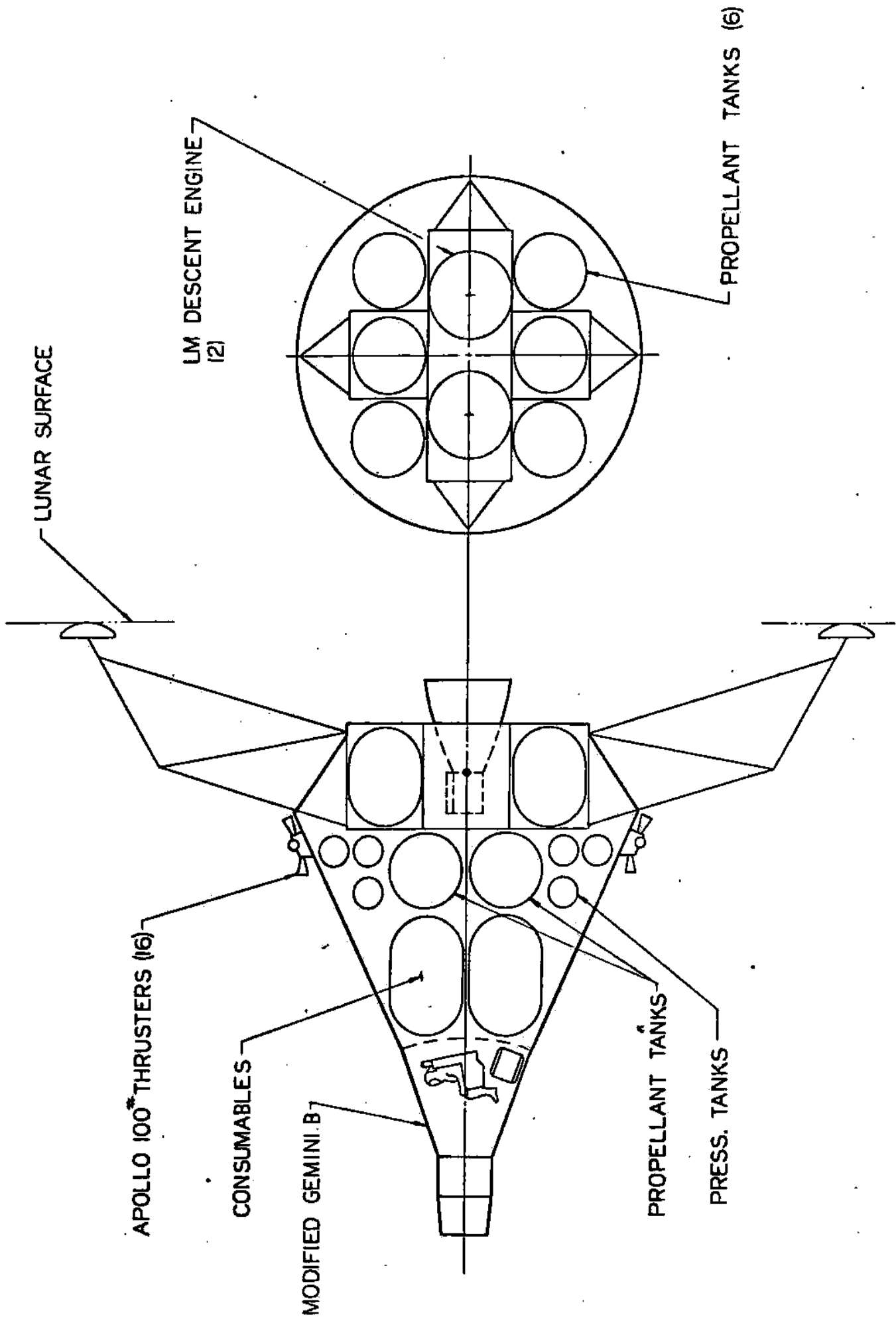

POTENTIAL GEMINI DERIVED RESCUE VEHICLES

- LUNAR ORBIT RESCUE
- LUNAR SURFACE RESCUE
- LUNAR SURFACE SURVIVAL SHELTER

LUNAR ORBIT RESCUE VEHICLE

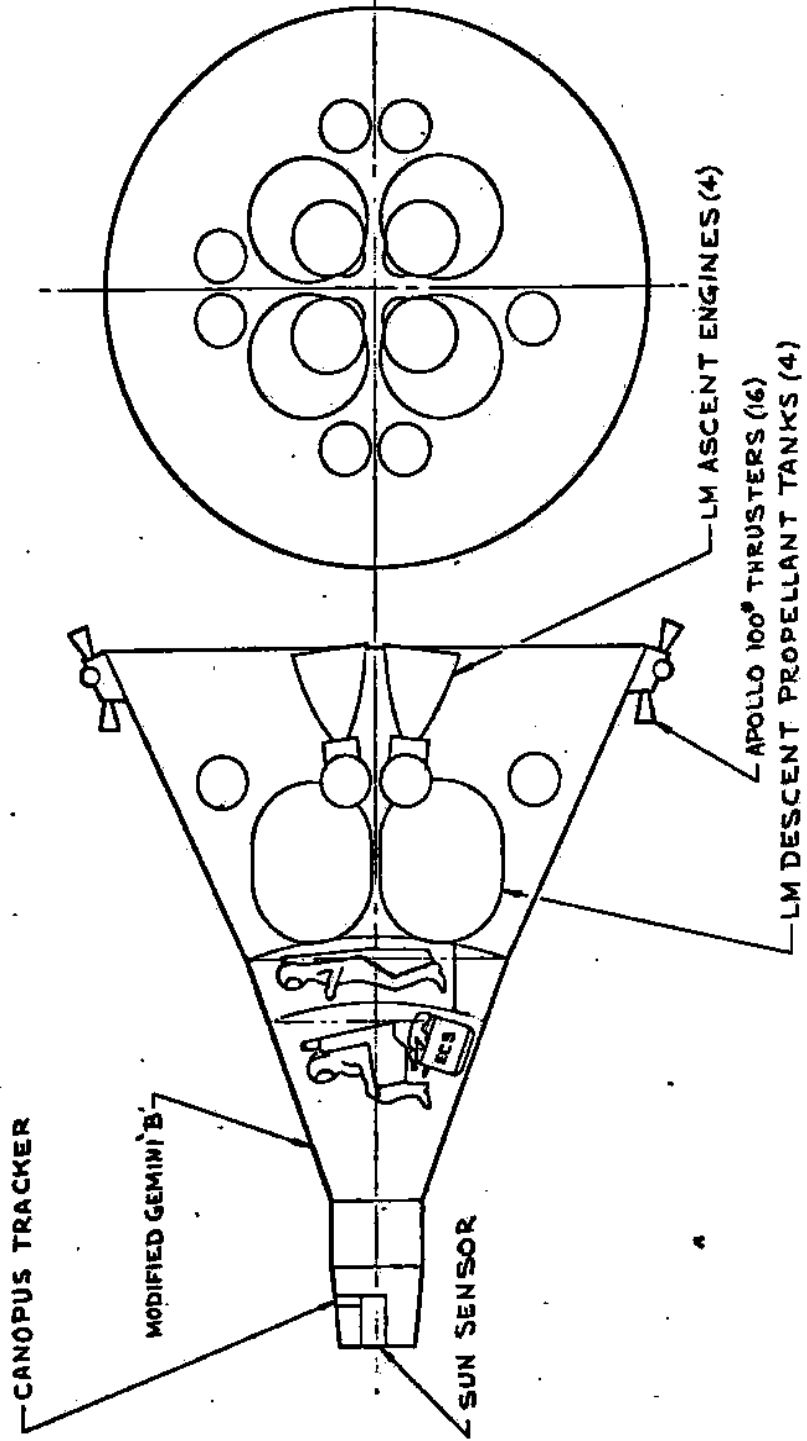

LUNAR RESCUE CONFIGURATIONS

	LUNAR ORBIT RESCUE		LUNAR SURFACE SURVIVAL SHELTER		LUNAR SURFACE RESCUE	
VEHICLE DESCRIPTION	<p>GEMINI</p> <p>MODIFIED GEMINI & REPACKAGED LM ASSENT STAGE</p>	<p>APOLLO</p> <p>APOLLO C/SM</p>	<p>GEMINI</p> <p>MODIFIED GEMINI & MODIFIED LM DESCENT STAGE</p>	<p>APOLLO</p> <p>MODIFIED APOLLO SM & MODIFIED LM</p>	<p>GEMINI</p> <p>MODIFIED GEMINI, REPACKAGED LM, MODIFIED LM DESCENT STAGES</p>	<p>APOLLO</p> <p>APOLLO C/SM & LM</p>
MISSION	<p>UNMANNED TO LUNAR ORBIT, THREE MAN DIRECT RETURN</p>	<p>UNMANNED TO LUNAR SURFACE, 28 DAY QUIESCENT STORAGE, 28 DAY 2-MAN OPERATION</p>	<p>UNMANNED TO LUNAR SURFACE, 30 DAY MANNED OPERATION</p>	<p>UNMANNED TO LUNAR ORBIT, 30 DAY UNMANNED QUIESCENT STAY, 2 MAN DIRECT RETURN</p>	<p>UNMANNED TO LUNAR ORBIT, LM TO LUNAR SURFACE, LM TO LUNAR ORBIT, 2 MAN RETURN</p>	<p>UNMANNED TO LUNAR ORBIT, LM TO LUNAR SURFACE, LM TO LUNAR ORBIT, 2 MAN RETURN</p>
ADVANTAGES	<ul style="list-style-type: none"> • USES DEVELOPED EQUIPMENT • NEW SPACECRAFT DEVELOPMENT 	<ul style="list-style-type: none"> • NO NEW DEVELOPMENT CAN BE ACCOMPLISHED WITH CURRENT ACQUISITIONS • POSSIBILITY OF SAME FAILURE MODE 	<ul style="list-style-type: none"> • EXTENSION OF LUNAR ORBIT VEHICLE • NEW SPACECRAFT DEVELOPMENT 	<ul style="list-style-type: none"> • SIMILAR TO PLANNED POST-APOLLO EXPLORATION SHELTER • REQUIRES MODIFICATIONS TO EXISTING HARDWARE 	<ul style="list-style-type: none"> • EXTENSION OF LUNAR ORBIT/SHELTER VEHICLE • NO RENDEZVOUS REQUIRED • DIRECT RETURN • NEW SPACECRAFT DEVELOPMENT 	<ul style="list-style-type: none"> • NO NEW DEVELOPMENT • SAME AS EXISTING MISSION
DISADVANTAGES	<ul style="list-style-type: none"> • DO NOT DEVELOP - RESCUE CAPABILITY TOO LIMITED, GREATEST EMERGENCY POTENTIAL AT LUNAR SURFACE 					<ul style="list-style-type: none"> • RENDEZVOUS REQUIRED • DIFFICULT TO AUTOMATE TRANSPOSE DOCKING
RECOMMENDATIONS						<ul style="list-style-type: none"> • MODIFY TO A UNIVERSAL RESCUE VEHICLE BY IMPROVING CAPABILITY TO COVER THREE-MAN CASES

MISSION SUMMARY - UNIVERSAL LUNAR RESCUE VEHICLE

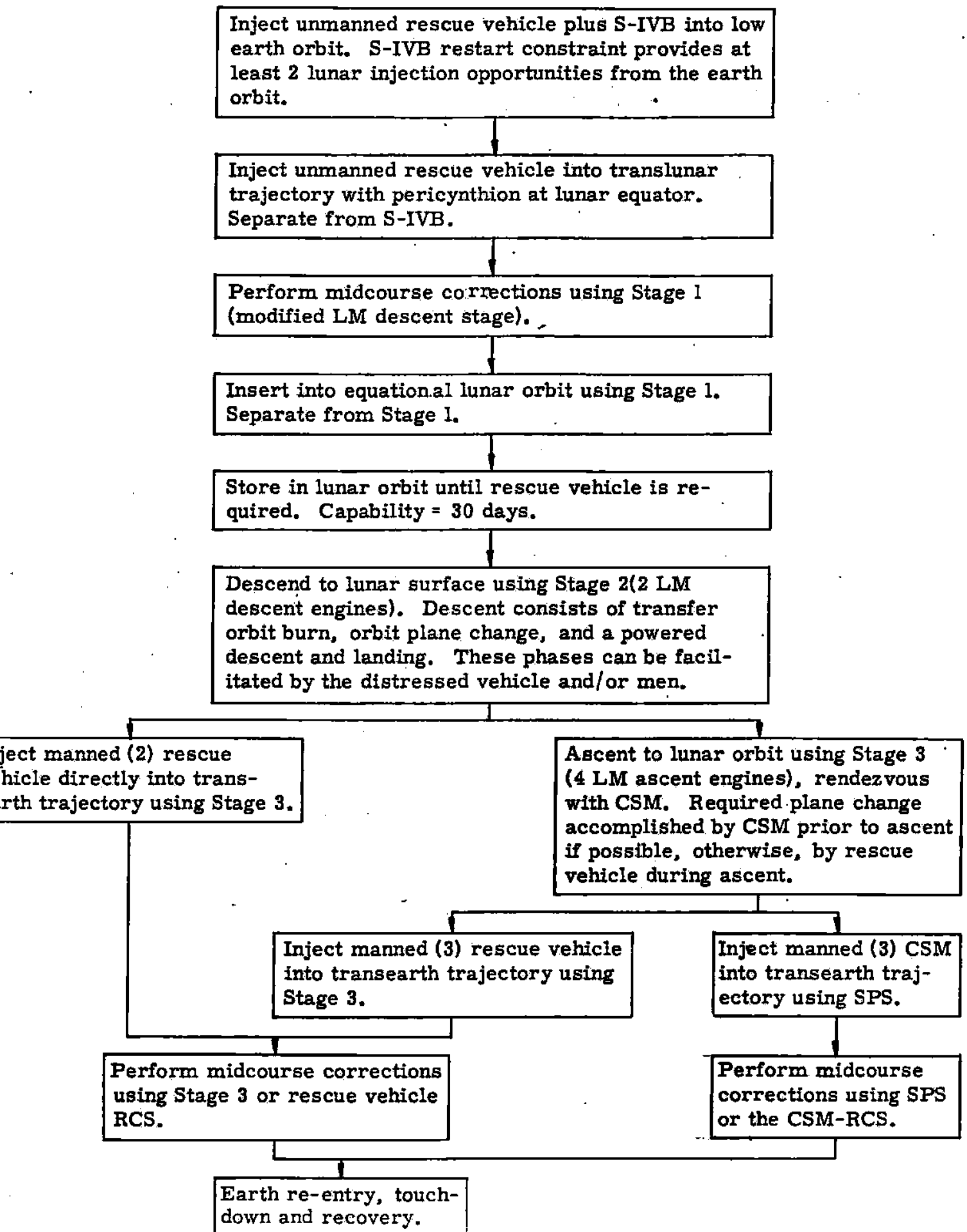

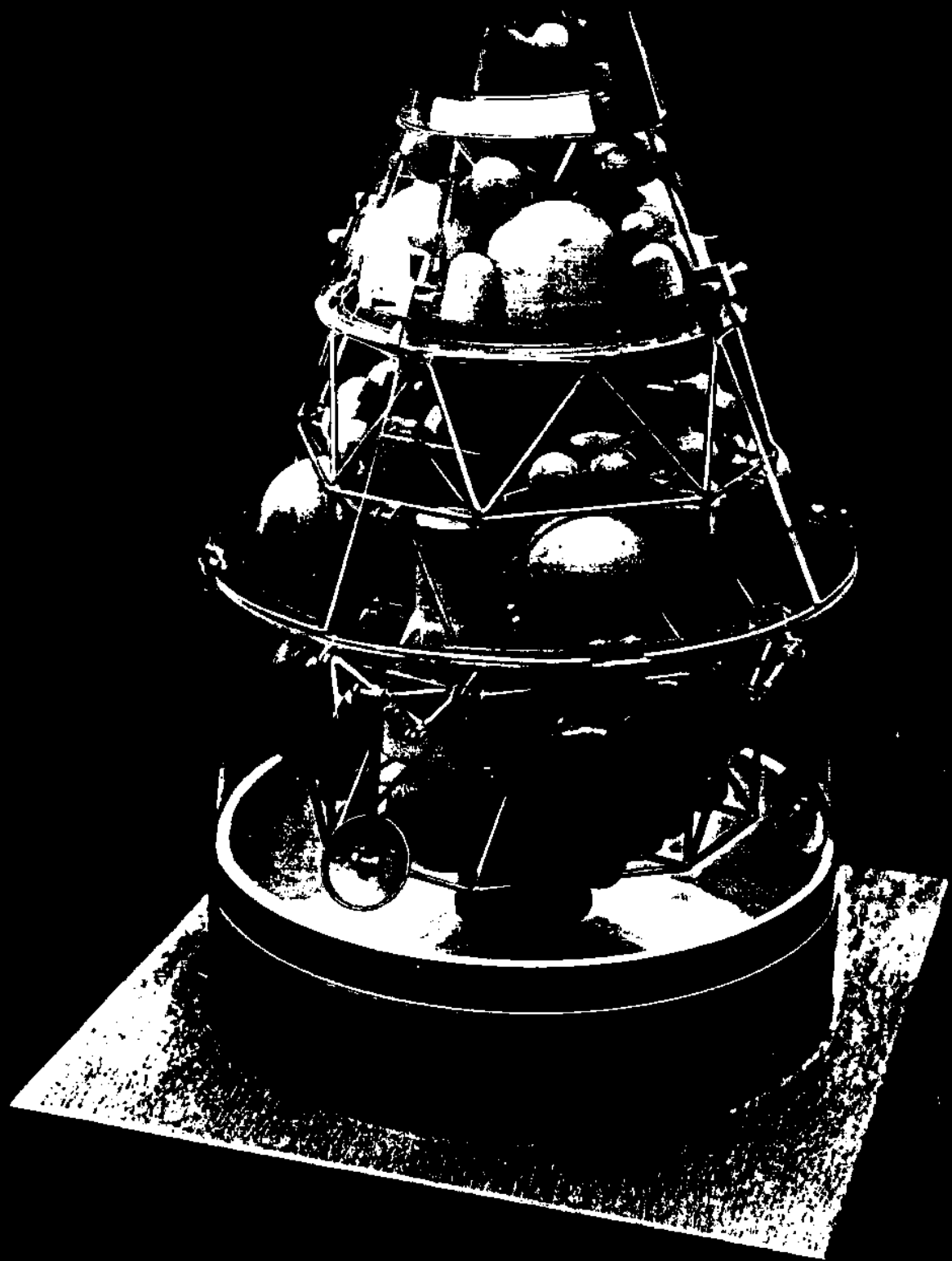

M-D-O PHOTO D4C-44697

~~NO DATE~~ (APR 67)

(APR 67)

~~MSO-0~~

DAC-44702

PHOTO

MSO-0

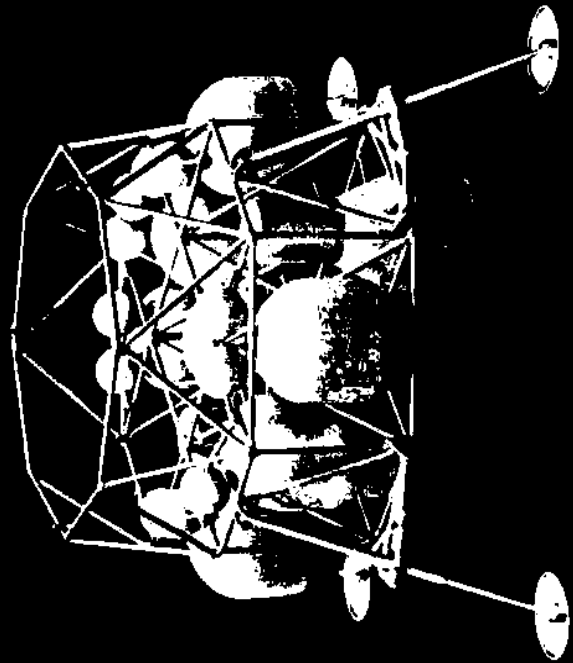
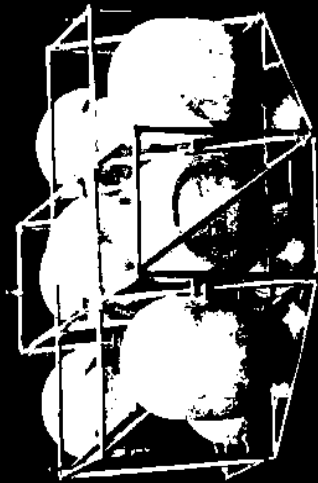

MEO-0 PHOTO

D4C-44695

APRIL 1967

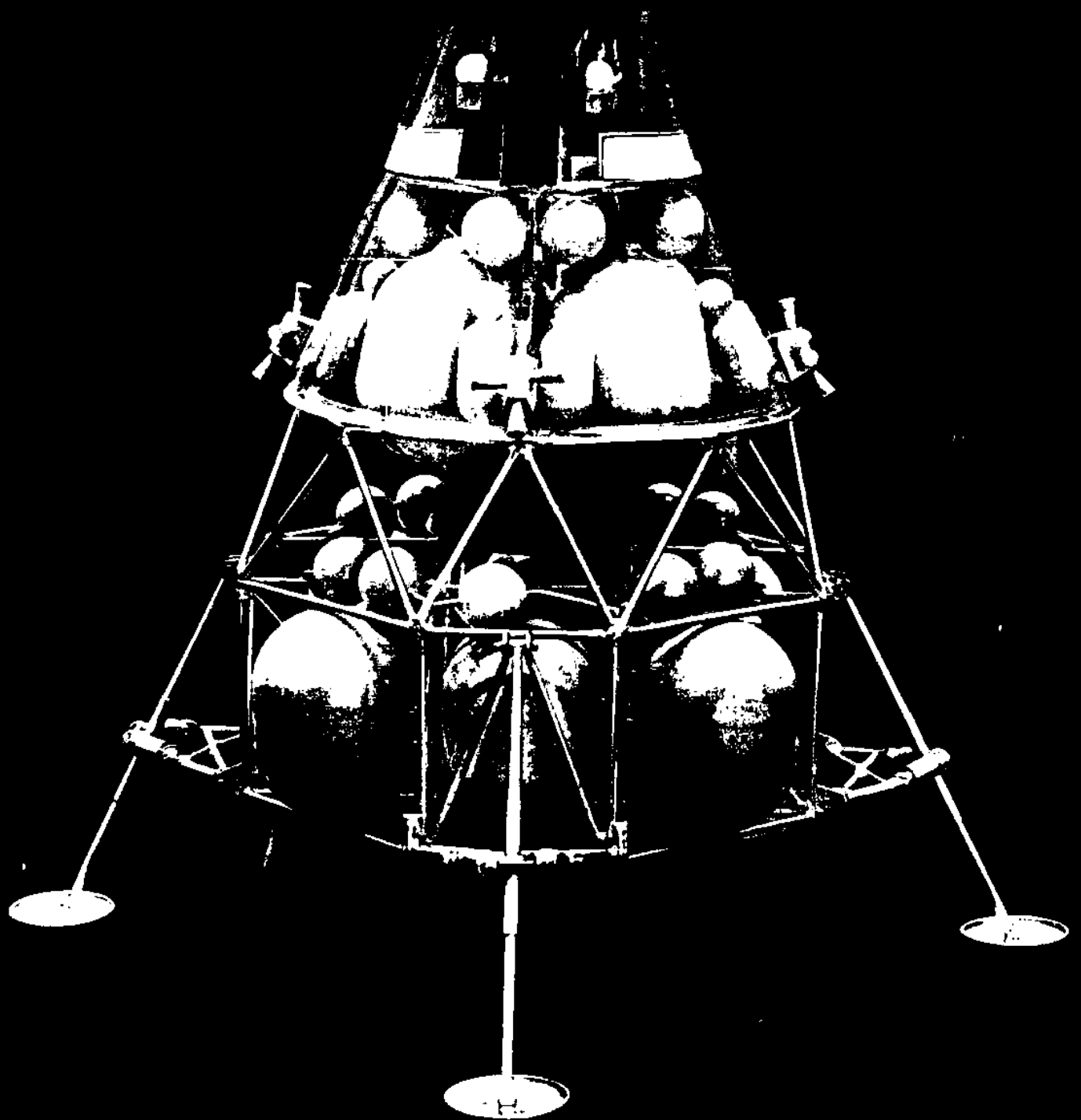

M60-D PHOTO # DAC-62377
MAY 1969

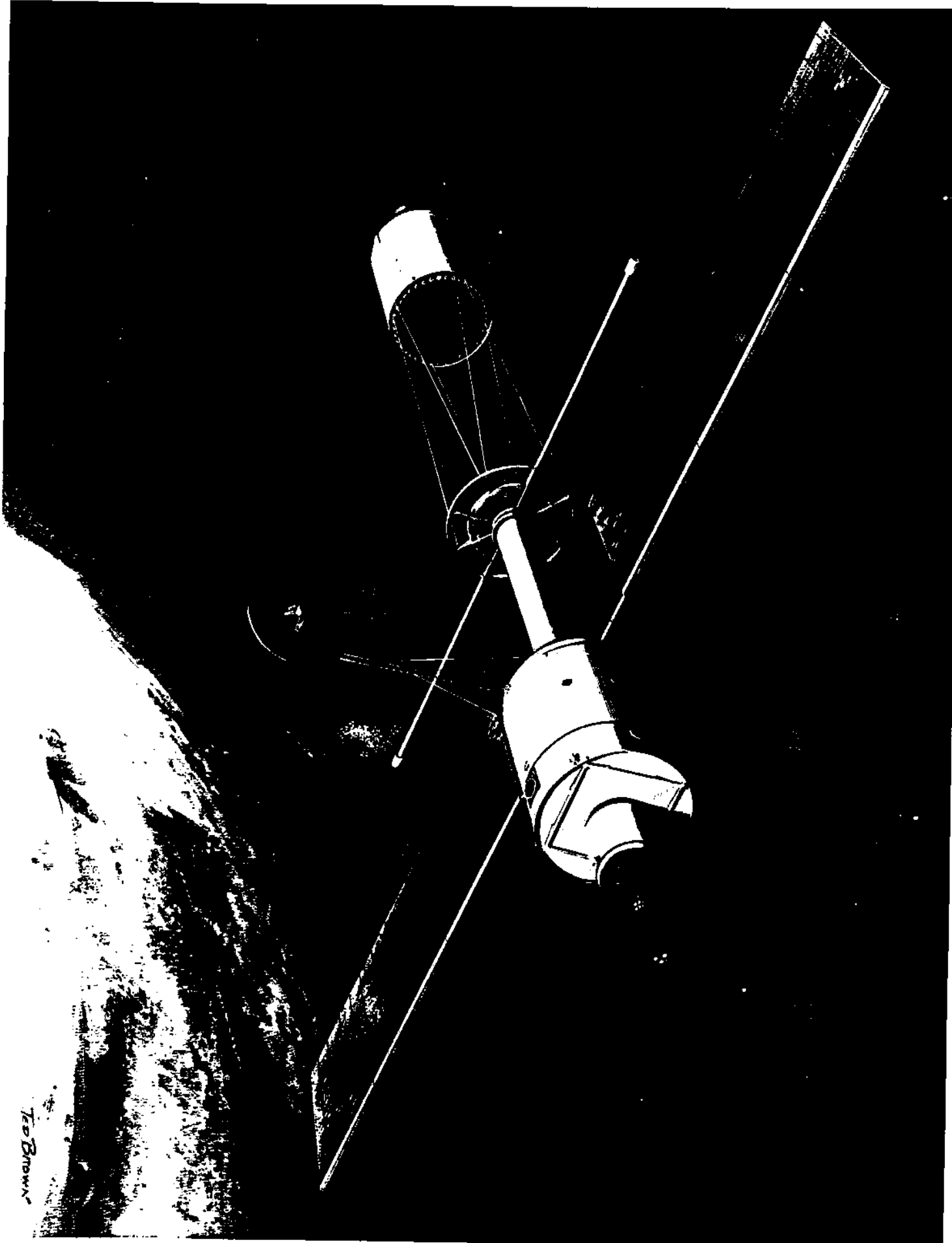

Les Brown